

HEAD OUTLINES

NOTE: DIMENSIONS ARE SHOWN IN INCHES OVER MILLIMETERS.

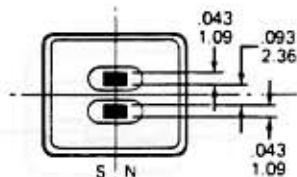

1B 1200/PB2Q

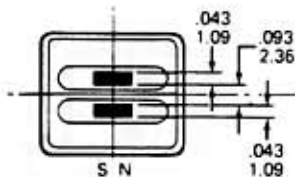

2B 8600/WPB2Q

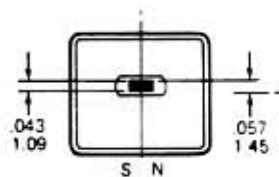

3B 7610/PB1QY

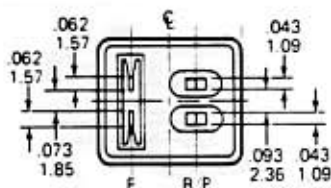

4B 6000/PA2Q

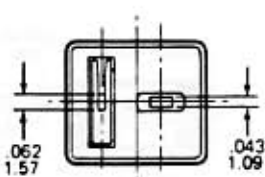

5B 6026/A1QC

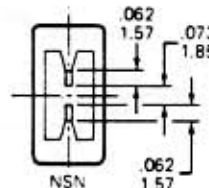

6SE 1400/SSEQ

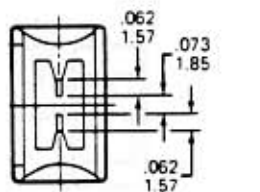

7LE 1400L/LSEQ

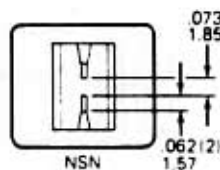

8B 8701/B2EQ

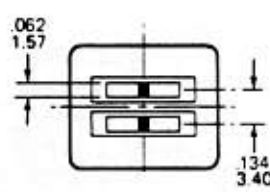

9B 8640/PRB2EQ

.100 TRACK SPACING
2.54 CENTER TO CENTER

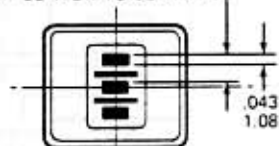

10B 5700/PB3Q

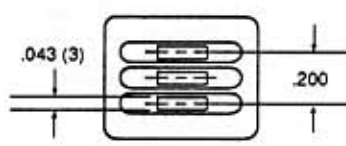

11B 5703D/LFPR3Q

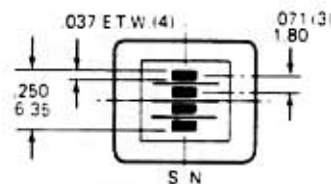

12B 5600/BQQ

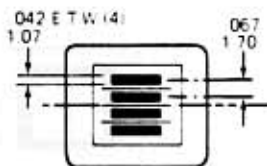

13B 5630/B4Q

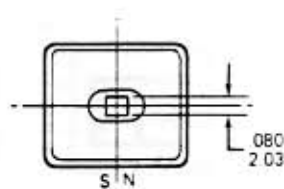
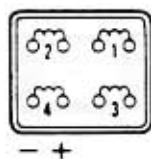

14B 7414/B1HC

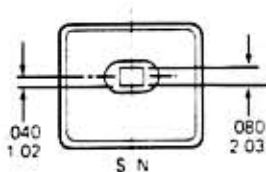

15B 8401/PB1HY

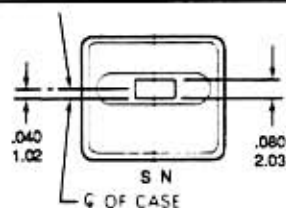

16B 8400/WPB1HY

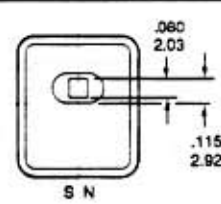

17G 3200/PG1H

HEAD OUTLINES

NOTE: DIMENSIONS ARE SHOWN IN INCHES OVER MILLIMETERS.

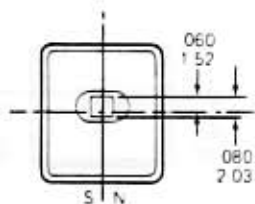

18G 3100/G1HY

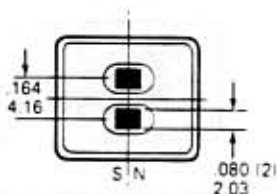

19B 2000/PB2H

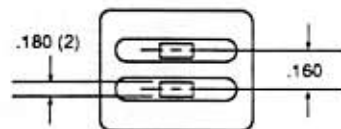

20B 2030/LFPR2H

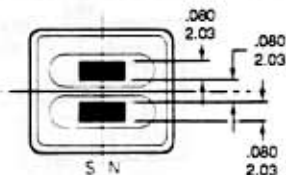

21B 8200/WPB2H

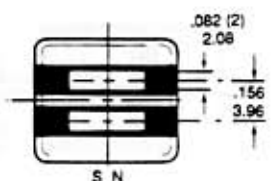

22B 9200/PRB2H

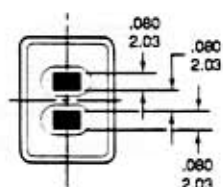

23C 7251/PC2H

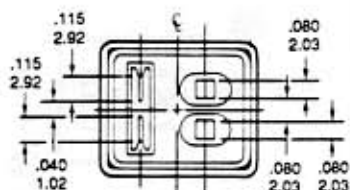

24B 6100/PA2H

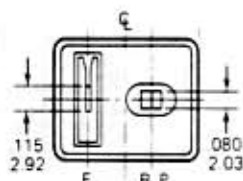

25B 6126/PA1HC

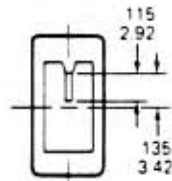

26SE 3600/SMEH

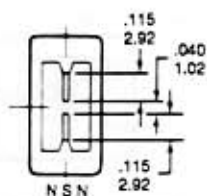

27SE 2200/SSEH

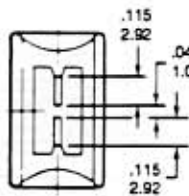

28LE 2200/LSEH

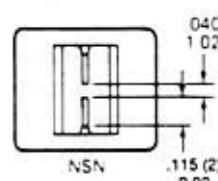

29B 8301/B2EH

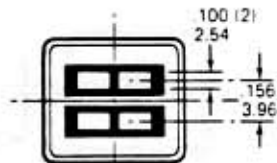

30B 9222/PRB2EH

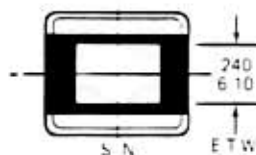

31B 9102/PRB1F

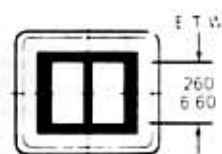

32B 9125/PRB1EF

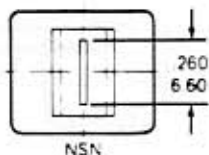

33B 8101/B1EF

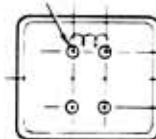

COIL TO UPPER PINS

HEAD OUTLINES

NOTE: DIMENSIONS ARE SHOWN IN INCHES OVER MILLIMETERS.

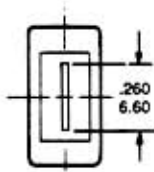

34SE 4400/SMEF

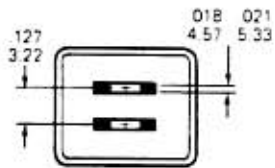

35B 5800/B2L

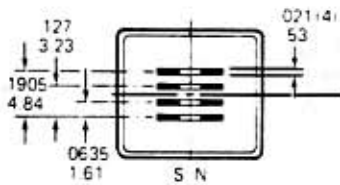

36B 5830/BQL

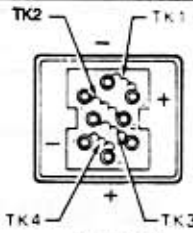

P-BQL

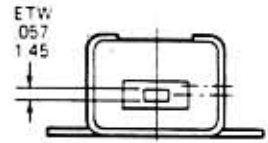

37W 5130/W1R

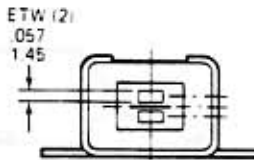

38W 5200/W2P

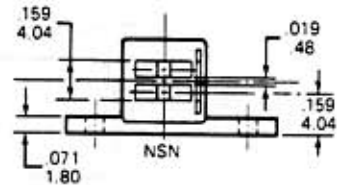

39W 5210/W2ER

"A" MOUNT STYLE

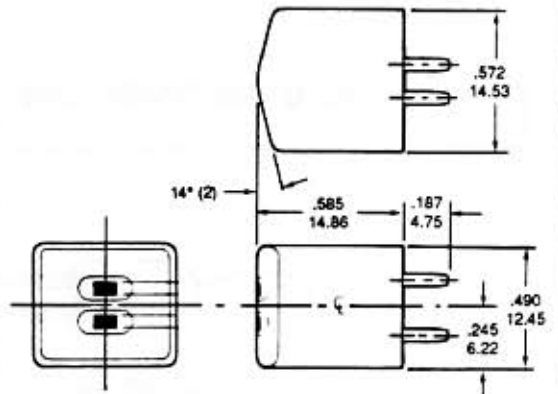
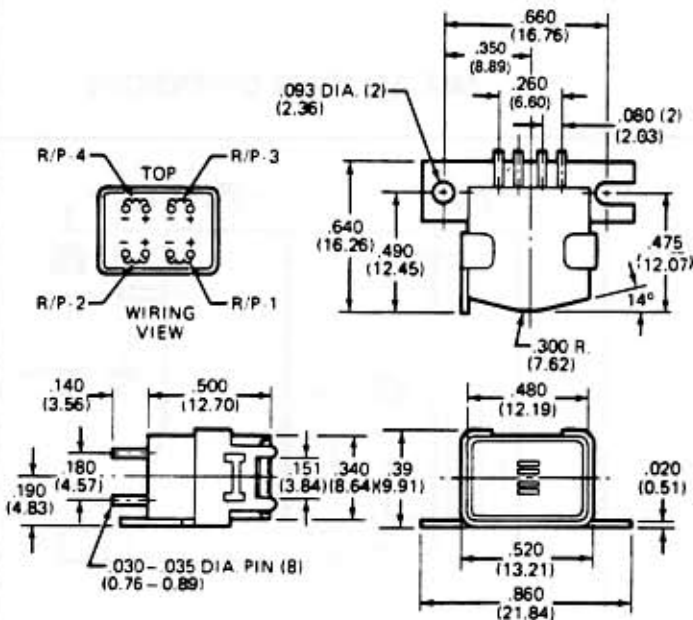

41B "B" SIZE DIMENSIONS

HEAD OUTLINES

NOTE: DIMENSIONS ARE SHOWN IN INCHES OVER MILLIMETERS.

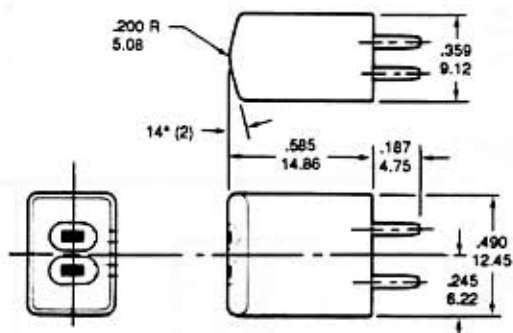

42C 'C' SIZE DIMENSIONS

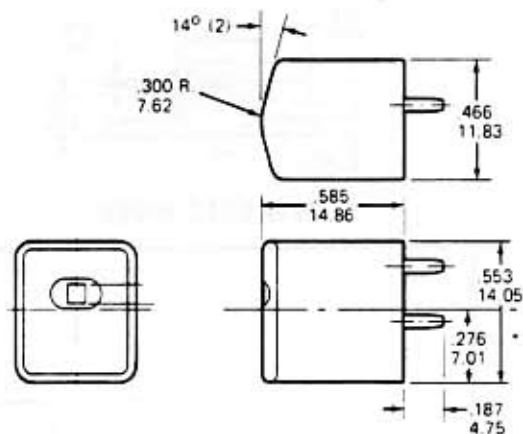

43G 'G' SIZE DIMENSIONS

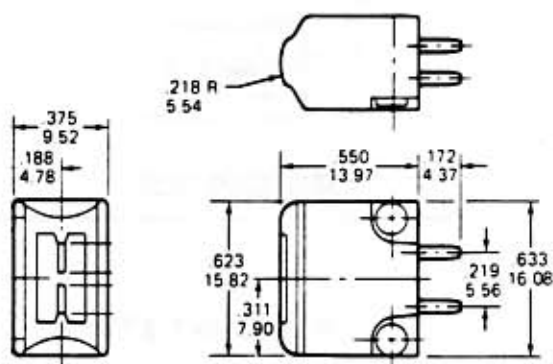

44LE 'LE' ERASE DIMENSIONS

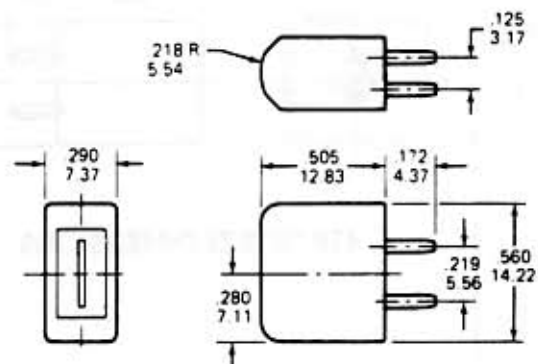

45SE 'SE' ERASE DIMENSIONS

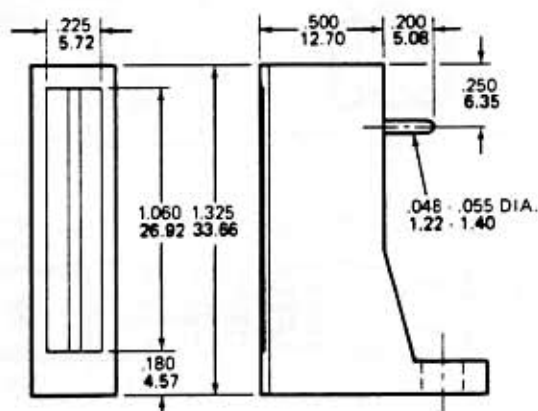

46RX 7721/REX-101

HEAD OUTLINES

NOTE: DIMENSIONS ARE SHOWN IN INCHES OVER MILLIMETERS.

TYPICAL REAR MOUNT

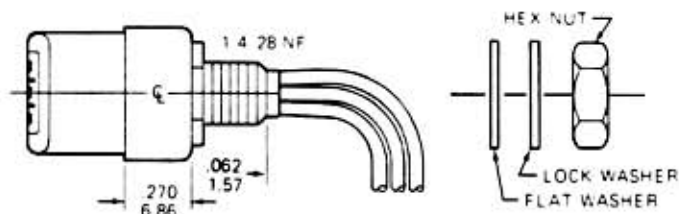

1 RED-ORG
2 YEL-BLU
Stereo Heads
1200/2000 etc.
B2Q/B2H/SEH

ERASE	R/P
1 BLK-WHT	RED-ORG
2 BRN-GRN	YEL-BLU
COMBO 6100/A2H/A1HC	
(Mono Use #1)	

1 BLK-RED
2 BRN-ORG
3 GRN-YEL
4 WHT-BLU
5600/5830
BQQ/BQL

1 RED-ORG
2 YEL-BLU
3 WHT-BLK
5700/B3Q

REAR MOUNT LEADS - COLOR CODE

47 REAR MOUNTS

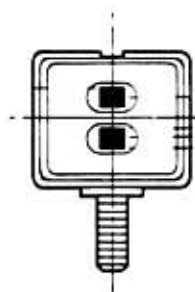

SINGLE 6-32 STUD
 (.200 inch back from from head face, spot welded to spring clip.)
 QK-19 "SE" Erase Heads
 QK-21 "G" Size R/P Heads
 QK-66 All "B" Size Heads

48 BASE MOUNT QUIK-KITS

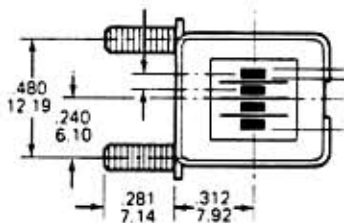

TWO 2-56 STUDS
 (On side of spring clip.)
 QK-18 "SE" Erase Heads
 QK-20 "G" Size R/P Heads
 QK-38 All "B" Size Heads

49 SIDE MOUNT QUIK-KITS